

Contact CI femelle 2,8 traversant

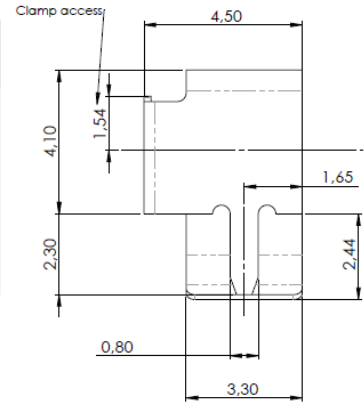

DÉTAIL VIEW OF CARRIER TAPE

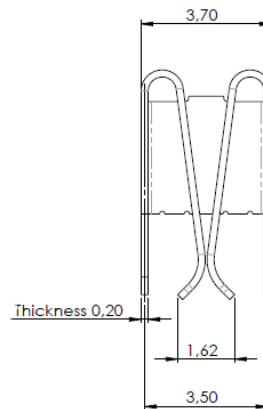
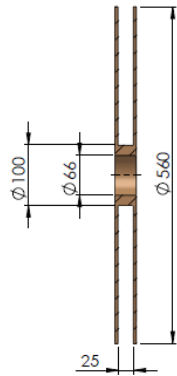
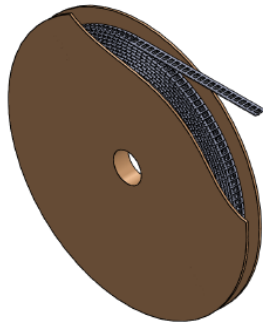
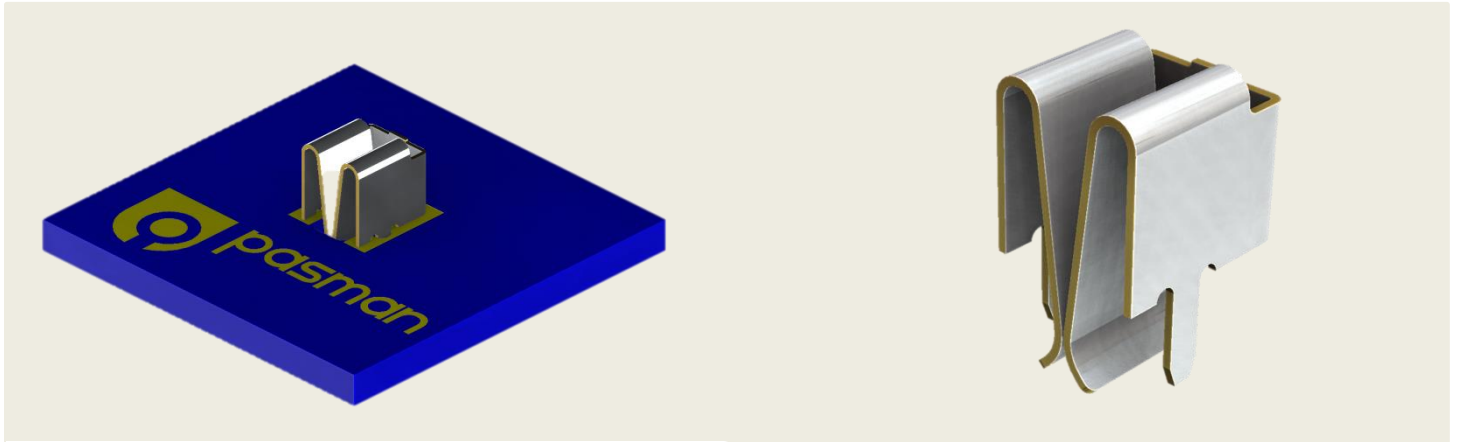
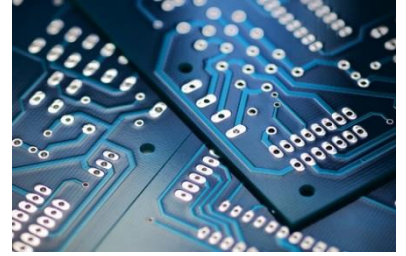
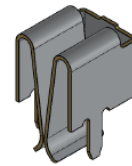
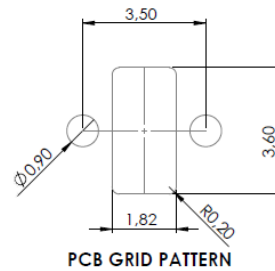
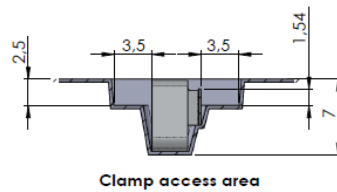
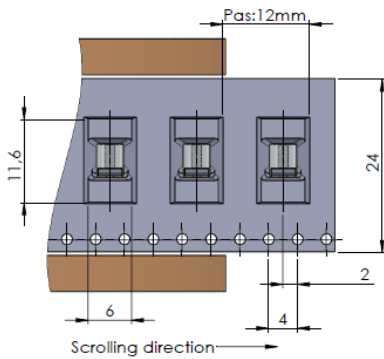

Scale 1:1

MATERIALS AND FINISHES:

- Contact: CuZn33 H14
- Contact protection: Sn 0.5-1.5 μ m
- Carrier tape black PS
- Cover Tape: Heat activated : PET
- Number of parts: approximately 2800 parts